

INSTALLATION INSTRUCTIONS

for suspended T35 profile system with exposed longitudinal profiles

These instructions apply to the installation of T35 profile system with exposed longitudinal profiles. Always check that you have the latest version of our installation instructions. Installation instructions for all Troldtekt® panels and installation systems can be downloaded at www.troldtekt.com.

INSTALLATION ON SUSPENDED T35 PROFILE SYSTEM WITH EXPOSED LONGITUDINAL PROFILES

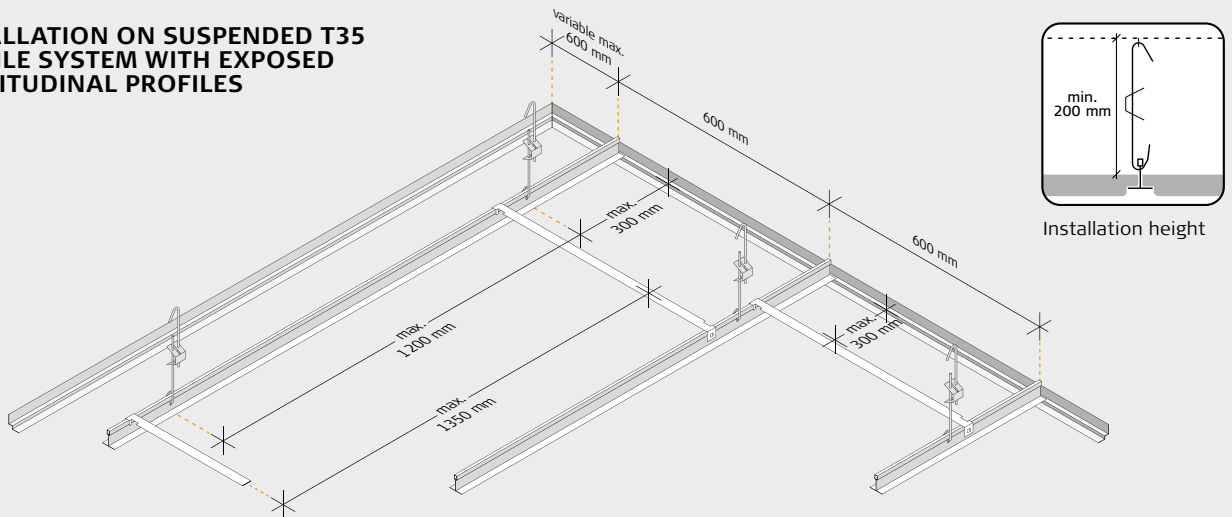

INSTALLATION

- 1: Fix the shadow-edge angle profiles (with the 8-mm tall side in vertical position) or the perimeter angle profiles securely to the wall with a maximum spacing of 300 mm. Additionally, fasten 50 mm from profile ends at joints, abutments and endings. (See figs. A and B). Hang the main profiles in parallel at 600 mm, with hanger points at max. 1200 mm. There should be max. 300 mm from the transverse wall to the first hanger. The main profiles and cross tees must lap on the perimeter angle or shadow-edge angle profiles (see figs. C and D).
- 2: Fix the quick-hangers securely to the structure above. In order to facilitate the

placing of the Troldtekt acoustic panels, the hooks on the adjustable quick-hangers must face the same way on the whole ceiling, as shown in fig. E, and the quick-hangers should be min. 200 mm. There should also be a distance of min. 200 mm to underlying installations, cable ducts etc., where the Troldtekt acoustic panels must be removable. In the case of increased loads from e.g. lightweight lighting armatures, the quick-hanger spacing should be reduced. Fix heavy armatures etc. to the structure above. Use a hacksaw or a profile cutter to shorten the profiles. Connect the main profiles by pushing the ends together so that they lock. (See figs F and G).

- 3: Once you have installed the profiles, check that all quick-hangers are tight. Adjust if necessary. Then position the Troldtekt acoustic panels row by row in the direction of the profiles. As you place the panels, fit spacing profiles (see fig. H) for every max. 1350 mm. The first spacing profile should be fitted max. 300 mm from the wall. Fit the spacing profiles on the suspended main profiles by clicking them onto the profile so they lock into place. (See fig. I.)

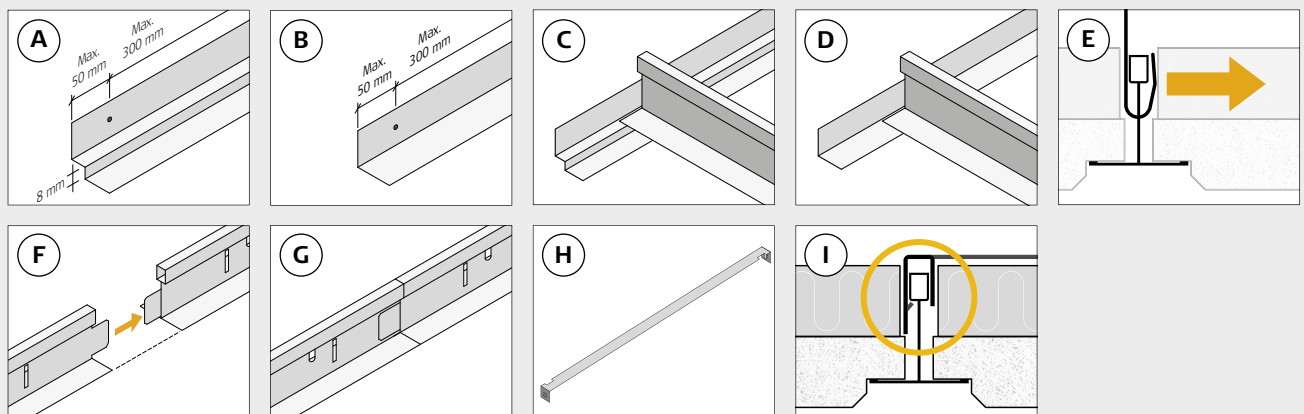

INSTALLATION PRINCIPLES

In a suspended T35 profile system with exposed longitudinal profiles, the panels can be installed in both stack bond (figs 1 and 2) or in stretcher bond (fig. 3). In both cases, about half of the panels will be removable. In order for the spacing profiles to stabilise the ceiling in the best possible way during installation, the panels should be installed

row by row following the direction of the profiles. It is a good idea to first secure the end of the spacing profile which is closest to you (see arrows A in the drawings below). The other end of the spacing profile can then be clicked into place on the main profile, for example by lightly banging it with a rubber hammer (see the arrows B in the drawings

below). Please note that the ceiling is not fully stabilised until all the spacing profiles are installed. To stabilise the profile system during installation, you can temporarily use spacing profiles to hold the profiles in place. (See marking C in drawings below.)

FIG.1 STACK BOND

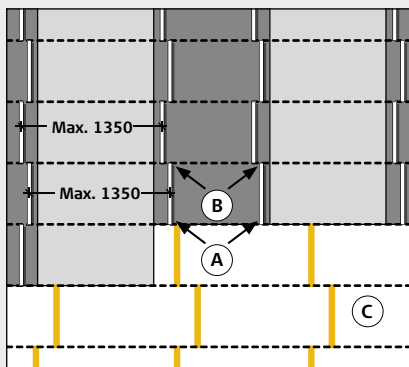

FIG. 2 STACK BOND, STAGGERED

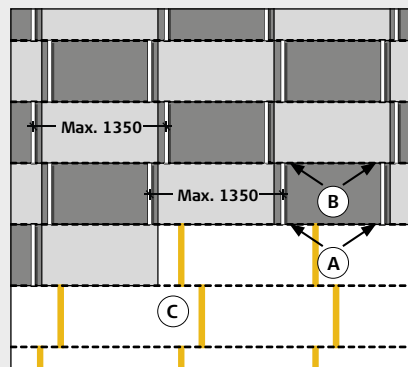
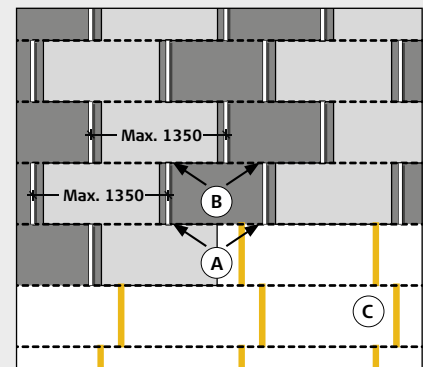
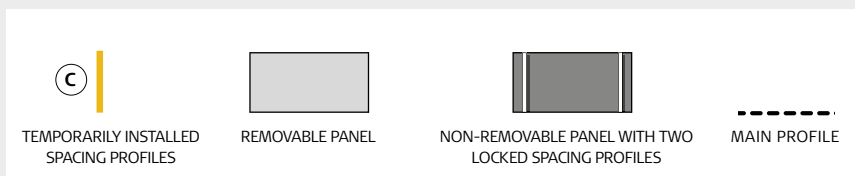

FIG. 3 STRETCHER BOND



SYMBOLS



CROSS-SECTION (PRINCIPLE)

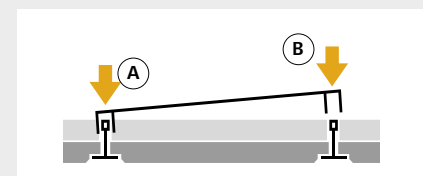

COMPONENTS



Product name	Perimeter angle profile, V-30 - 30x30 mm	Shadow-edge angle profile, W-8 -17+14 / 8+17 mm	Main profile, T-35 - 35x38 mm
Size/length (mm)	3000	3000	3700
Quantity per pack	25 pcs.	25 pcs.	12 pcs.
Approx. qty. per m ²	According to measurement	According to measurement	0,83 pcs.



Product name	Adjustable hanger	Spacing profile with lock*
Size/length (mm)	175-275 / 230-360 / 300-600 / 500-1000 / 1000-2000	600
Quantity per pack	100 pcs.	50 pcs.
Approx. qty. per m ²	1,4 pcs.	1,4 pcs.

* Not compatible with Troldtekt® Plus 40 mm acoustic panels and Troldtekt® ventilation with edge K0-S.