

INSTALLATION INSTRUCTIONS

Troldtekt® acoustic panels corner cloud Installed as floating corner cloud on C60 profiles

These instructions apply to installation of floating corner cloud on C60 profiles.
Download installation instructions for all Troldtekt® panel types from www.troldtekt.com.

INSTALLATION AS FLOATING CORNER CLOUD ON C60 PROFILES

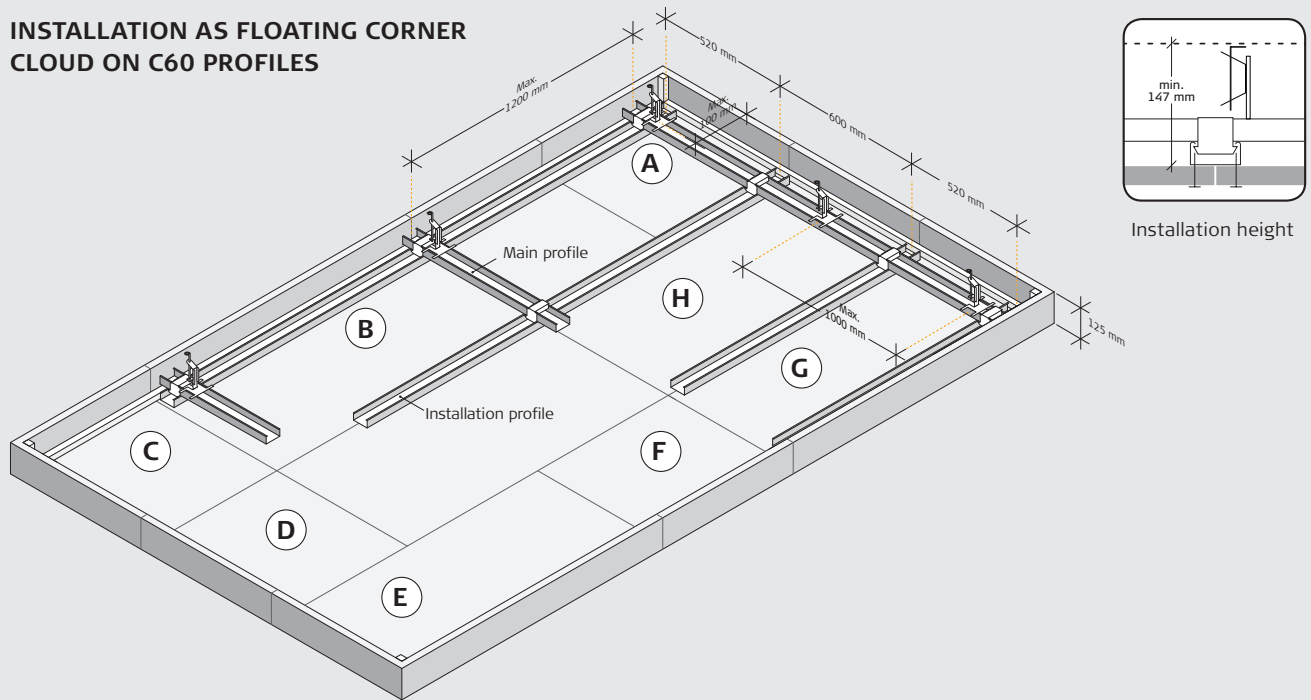

TROLDTEKT® CORNER CLOUD PANEL TYPES, HEIGHT = 125 MM

A	B	C	D	E	F	G	H
Corner element 600x600 mm (type 1)	Side element 600x1200 mm (longitudinal edge)	Corner element 600x600 mm (type 2)	Side element 600x600 mm (transverse edge)	Corner element 600x1200 mm (type 1)	Side element 600x600 mm (longitudinal edge)	Corner element 600x1200 mm (type 2)	Side element 600x1200 mm (transverse edge)

STRUCTURAL SOFFIT

1: Start by calculating the precise cloud dimensions. Determine and mark the anchor points for the main profiles based on the cloud size minus 100 mm longitudinally and transversally. Install quick-hangers in the four corner anchor points, and distribute the remaining quick-hangers with a max. spacing of 1000 mm. Assemble ring hook and quick-fit suspension bracket to the desired length and install them on the ceiling drive anchor before further installation. Drill 6-mm holes in the concrete deck and install the ceiling drive anchor with ring hook and quick-fit suspension bracket by striking the ceiling drive anchor into the hole until it is lodged. Then bend the ring hook into

vertical position. Alternatively, screw the ring hooks into a steel or wooden base.

2: Hold a main profile (C60 profile) with the opening facing upwards and click the profile over the quick-fit suspension bracket at every hanger point. Assemble the C60 profiles longitudinally using C-connectors.

3: Then click the installation profiles (C60 profiles) on the main profiles using the cross connectors.

Note: If the lateral position of the profiles is not entirely precise, you can easily push the profile in the cross connector.

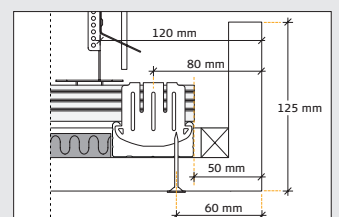
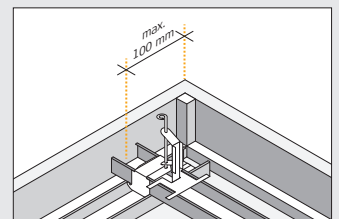

INSTALLATION

1: Start by installing a complete row of Troldtekt Plus panels along the centre line of the cloud. Then continue on both sides. It is important that the panels are installed closely together, and the optimum aesthetic effect is obtained by installing the panels in broken bond.

2: Fix the panels using Troldtekt self-tapping screws spaced 60 mm from the edges – as indicated in the figure below. Be careful not to overdrive the washered screws and so cause an indentation in the panel.

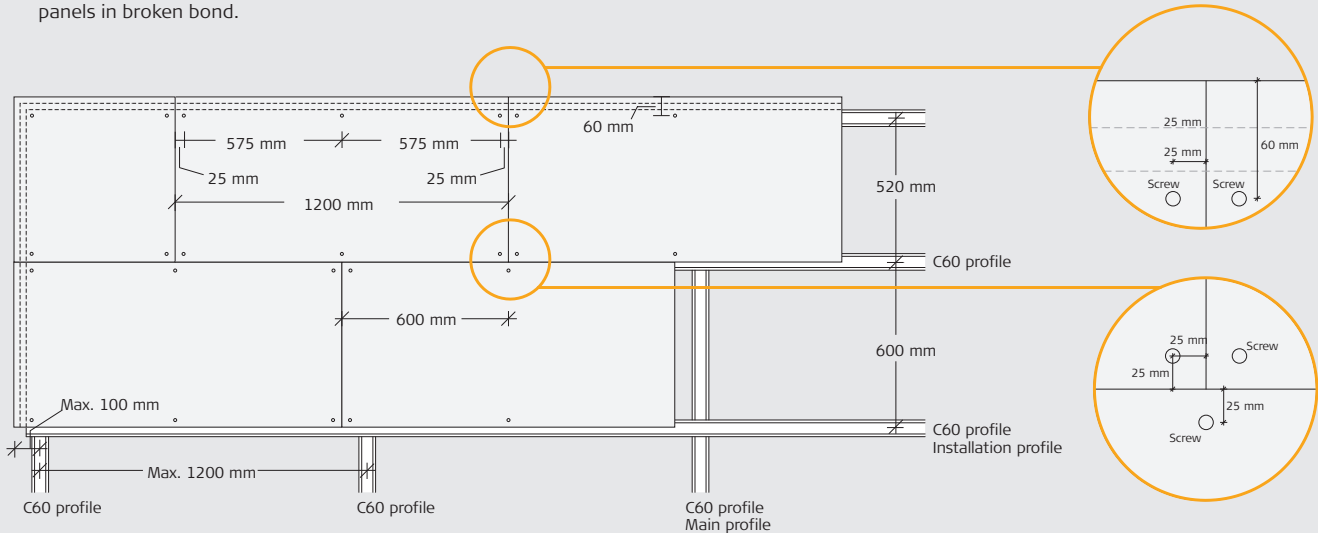

COMPONENTS

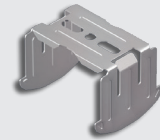
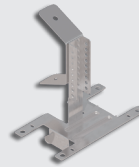
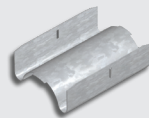
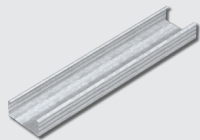

Product name	C60 profile 60×27 mm	C-connector	C-quick-fit suspension bracket	C-cross connector
Length (mm)	4000	80	100	
Quantity per pack	12 pcs.	100 pcs.	50 pcs.	100 pcs.
Approx. qty. per m ²	2.5 linear m	0.6 pcs.	1.1 pcs.	1.4 pcs.

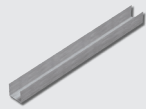

Product name	U-profile 28×27 mm	Ring hook	Ceiling drive anchor	Troldtekt structure screw (PH2)
Length (mm)	3000	120, 250, 375, 500, 750, 1000	6.0×40	4.2×45
Quantity per pack	16 pcs.	100 pcs.	100 pcs.	100 pcs.
Approx. qty. per m ²	According to measurement	1.1 pcs.	1.1 pcs.	Panel length: 600: 4 pcs. per panel 1200: 6 pcs. per panel 2400: 10 pcs. per panel

Please see installation instructions for c60 profile system for information on nonius brackets etc.